

DITITAL MULTIMETER

MODEL: GDM-8145

82DM-81450MG

EC Declaration of Conformity

We

GOOD WILL INSTRUMENT CO., LTD.

No. 95 - 11, Pao Chung Rd., Hsin-Tien City, Taipei Hsien, Taiwan

GOOD WILL INSTRUMENT (SUZHOU) CO., LTD.

No.69 Lushan Road, Suzhou New District Jiangsu, China.

GDM-8145

is herewith confirmed to comply with the requirements set out in the Council Directive on the approximation of the Law of Member States relating to Electromagnetic Compatibility (89/336/EEC, 92/31/EEC,93/68/EEC) and Low Voltage Equipment Directive (73/23/EEC, 93/68/EEC).

For the evaluation regarding the Electromagnetic Compatibility and Low Voltage Equipment Directive, the following standards were applied:

EN 61326-1:Electrical equipment for measurement, control and laboratory use—EMC requirements (1997+A1:1998)				
Conducted Emission	EN 55011 (1991)		Electrostatic Discharge	EN 61000-4-2 (1995)
Radiated Emission	Group I Class B		Radiated Immunity	IEC 1000-4-3 (1994)
Current Harmonics	EN 61000-3-2	(1996)	Electrical Fast Transients	EN 61000-4-4 (1995)
Voltage Fluctuations	EN 61000-3-3	(1995)	Surge Immunity	EN 61000-4-5 (1995)
-----	-----	-----	Conducted Susceptibility	EN 61000-4-6 (1996)
-----	-----	-----	Power Frequency Magnetic field	EN 61000-4-8 (1993)
-----	-----	-----	Voltage Dip/Interruption	EN 61000-4-11 (1994)
Low Voltage Equipment Directive 73/23/EEC & amended by 93/68/EEC				
IEC/EN 61010-1: 2001				

FOR UNITED KINGDOM ONLY

This lead/appliance must only be wired by competent persons

WARNING

THIS APPLIANCE MUST BE
EARTHED
IMPORTANT

The wires in this lead are coloured in accordance with the following code:

Green/
Yellow: Earth
Blue: Natural
Brown: Live(Phase)



As the colours of the wires in main leads may not correspond with the colours marking identified in your plug/appliance, proceed as follows:

The wire which is coloured Green & Yellow must be connected to the Earth terminal marked with the letter E or by the earth symbol \perp or coloured Green or Green & Yellow.

The wire which is coloured Blue must be connected to the terminal which is marked with the letter N or coloured Blue or Black.

The wire which is coloured Brown must be connected to the terminal marked with the letter L or P or coloured Brown or Red.

If in doubt, consult the instructions provided with the equipment or contact the supplier.

This cable/appliance should be protected by a suitably rated and approved HBC mains fuse; refer to the rating information on the equipment and/or user instructions for details. As a guide, cable of 0.75mm² should be protected by a 3A or 5A fuse. Larger conductors would normally require 13A types, depending on the connection method used.

Any moulded mains connector that requires removal/replacement must be destroyed by removal of any fuse & fuse carrier and disposed of immediately, as a plug with bared wires is hazardous if engaged in a live socket. Any re-wiring must be carried out in accordance with the information detailed on this label.

SAFETY TERMS AND SYMBOLS

These terms may appear in this manual or on the product:

WARNING. Warning statements identify condition or practices that could result in injury or loss of life.

CAUTION. Caution statements identify conditions or practices that could result in damage to this product or other property.

The following symbols may appear in this manual or on the product:



DANGER
High Voltage



ATTENTION
refer to Manual



**Protective
Conductor
Terminal**



**Earth
(Ground)
Terminal**

TABLE OF CONTENTS

SECTION 1	PAGE		
INTRODUCTION & SPECIFICATIONS	1		
1-1. INTRODUCTION	1		
1-3. UNPACKING YOUR INSTRUMENT	1		
1-6. GETTING ACQUAINTED	2		
1-9. USING YOUR METER	2		
1-11. The LED	2		
1-14. POWER Switch	2		
1-16. Voltage Measurements	3		
1-18. Linear Voltage Measurements	3		
1-22. Current Measurements	3		
1-25. Resistance Measurements	4		
1-28. SPECIFICATIONS	4		
SECTION 2			
OPERATING INSTRUCTIONS	10		
2-1. INTRODUCTION	10		
2-3. OPERATING NOTES	10		
2-5. Input Overload Protection	10		
2-7. Input Connections to Common	10		
2-9. Operating Power	10		
2-11. MEASUREMENT TECHNIQUES	11		
2-13. Voltage Measurement Techniques	11		
2-23. Current Measurement Techniques	12		
2-26. Resistance Measurement Techniques	12		
2-31. AC Measurement Techniques	15		
		2-53. OPERATION	19
		2-55. APPLICATIONS	19
		SECTION 3	
		MAINTENANCE	20
		3-1. INTRODUCTION	20
		3-3. SERVICE INFORMATION	20
		3-7. GENERAL INFORMATION	20
		3-8. Access Information	20
		3-15. Changing Input Power Configuration	22
		3-17. Fuse Replacement	22
		3-19. Cleaning	22
		3-21. PERFORMANCE TEST	22
		3-23. Display Test	22
		3-25. Linear Voltage Test	23
		3-27. Current Test	24
		3-29. Resistance Test	24
		3-31. CALIBRATION ADJUSTMENTS	24
		3-33. DC Calibration	25
		3-35. AC Calibration	25
		SECTION 4	
		SCHEMATIC DIAGRAMS	26

Section 1

INTRODUCTION & SPECIFICATIONS

1-1. INTRODUCTION

1-2. This instrument is a portable, bench-type digital multimeter with a 4-1/2 digit L.E.D. display. The DMM can measurements — ac/dc volts, ac/dc current, and resistance. Some of the advantages of owning:

TRUE RMS MEASUREMENT OF AC or AC+DC SIGNALS: True RMS measurement is the only accurate way to directly measure ac or ac+dc signals that are not noise-free pure sine waves. This instrument measures ac voltage frequencies up to 50kHz.

FIVE MEASUREMENT FUNCTIONS:

AC and DC VOLTS: Standard linear voltage measurements from 10 μ V to 1200V dc and 10mV to 1000V ac or ac+dc true rms.

AC and DC CURRENT: Standard current measurements from 10nA to 20A dc and 10 μ A to 20A ac or ac+dc true rms.

RESISTANCE: Standard resistance measurements from 10m Ω to 20M Ω .

EACH MEASUREMENT RANGE HAS:

- Autopolarity operation.
- Overrange indication.
- Effective protection from overloads and transients.
- Dual slope integration measurement technique

to insure fast, accurate, noise-free measurements.

DIODE TEST: Ranges of the resistance function that will turn on PN junctions allowing testing of diodes and transistors. These ranges are marked with a diode symbol on the front panel of your DMM. The preferred 2k Ω range is marked with the largest diode symbol.

IMPROVED TEST LEADS: Finger guards on the probes and shrouded contacts on the input terminals decrease the possibility of accidental contact with circuit voltage.

LONG-TERM CALIBRATION STABILITY:

1-year.

ACCESSORIES: A line of accessories that extend the range and scope of your instrument. These accessories are listed in showing:

Test Lead GTL-107.	x 1
Instruction Manual.	x 1

1-3. UNPACKING YOUR INSTRUMENT

1-4. The shipping container should contain this manual, your multimeter, test leads (one red and one black), and any accessories you have ordered. Check the shipment for damage.

1-5. Turn this instrument Rear Side. The decal on the panel of your instrument is marked with the line voltage

and frequency required for proper operation. Refer to Section 3 if a change in the input power configuration is desired.

1-6. GETTING ACQUAINTED

1-7. Let's take a brief look at your DMM before we discuss exactly how to operate it. Your meter is light-weight with a low profile that hugs the work bench. The light-grey case is made of rugged, high-impact plastic. The handle can be rotated to eight positions.

1-8. The input connector is on the left side of the front panel. The right side of your DMM contains two rows of switches and LED display. The power cord receptacle is located on the rear panel of your DMM.

1-9. USING YOUR METER

1-10. The following paragraphs describe each of the controls on your DMM and how these controls can be used for each instrument function. Exercises are included to help familiarize you with your DMM and to verify that your instrument is functional.

1-11. The LED

1-12. The LED is high-contrast display. The 4-1/2 digits — easily read from across the room — can register from 0000 to 19999. For ease of discussion, the 19999 will be rounded to 20000 in the remainder of this text. For example, we will refer to the 2V range, not the 1,9999V

range. In all linear functions, the decimal point position is determined by the range selected. Polarity of the input signal is indicated by a - sign at the center of the left side of the LED. The + sign is disabled in the AC V, AC mA, and K Ω measurement functions. The - sign may appear in any measurement function, but is normally not meaningful when making AC V, AC mA, and K Ω measurements. You will only get this indication of an energized circuit if the power in the circuit is negative with respect to the COMMON input terminal. If the power in the circuit is positive with respect to the COMMON input terminal, an erroneous resistance will be displayed. If there is any doubt about whether there is energy remaining in the circuit you are reading, read the resistance, then reverse the test lead positions. If the minus sign is displayed in either case, the remaining energy must be removed from the circuit before correct resistance readings can be made.

1-13. If you apply an input signal that exceeds the limits of the range selected, the LED will be flasher in the all digit locations. All decimal point positions appear in the display to indicate certain illegal combinations of front panel switch settings. For example, if you select the DC V function and the 20M range switch, all four decimal points will appear on the display.

1-14. POWER Switch

1-15. The Red POWER switch is located in the right corner of the DMM front panel. This is a push-pull switch so don't try to pull the POWER switch to the

OUT (OFF) position. Push the POWER switch on your DMM to the IN (ON) position.

1-16. Voltage Measurements

1-17. Your DMM can make either linear voltage or AC +DC TRUE RMS voltage measurements. For both types of voltage measurements, plug the black test lead into the COMMON terminal and the red test lead into the V- Ω terminal.

1-18. Linear Voltage Measurements

1-19. The controls and terminals used for making linear voltage measurements on the front panel. Starting at the top left is the ACV/DCV switch. This pushbutton is interlocked with the other two white function selection switches — mA and K Ω . That is, if the DCV function switch is at the IN position (DCV selected), and any other function select switch is pushed, the DCV pushbutton will be released to the OUT position. Push the DCV switch to the IN position.

1-20. The light gray area around the ACV/DCV switch is extended up and to the right to enclose the five range values of the voltage function. Push the range switch immediately below the range value desired to select a range of voltage measurement. The range select switches are interlocked in the same manner as the function switches.

1-21. Perform the following procedure:

1. If the test leads are not connected, plug them into your DMM: red test lead to the V- Ω terminal and black to the COMMON terminal.
2. Select the 0.2V range.
3. Push the function switch to the DCV position.
4. With the POWER switch set to the OFF position, connect your DMM to a line power outlet rated at the operating voltage and frequency of your instrument.
5. Push the POWER switch to the ON position. The LED should count down rapidly to a reading of $< \pm .0020$.
6. Select the ACV and 1000V range.

WARNING

LOCAL LINE VOLTAGE IS MEASURED IN THE FOLLOWING STEP. BE CAREFUL NOT TO TOUCH THE PROBE TIPS WITH YOUR FINGERS OR TO ALLOW THE PROBE TIPS TO TOUCH EACH OTHER.

7. Insert the sampling ends of the test leads into the slots of a power outlet. The LED should display the true local line voltage.
8. Push the DCV push-button switch. The LED should display near zero volts but there may be some residual dc voltage on the power line due to non-linear loads such as SCR light dimmers.
9. Remove the test leads from the line power outlet.

1-22. Current Measurements

1-23. All of the controls and terminals used to make

current measurements on the front panel. The AC mA and DC mA function switches determine the measurement function. The colored area around the 20A switch extends up and to the right to enclose the six range values for the 20A measurement function. Push the ranges switch immediately below the range value desired to select a range of current measurement.

1-24. As the colored areas around the terminals indicate, the red test lead should be plugged into the 2A or 20A terminal and the black test lead should be plugged into the COMMON terminal.

1-25. Resistance Measurements

1-26. The controls and terminals used to make resistance measurements on the front panel. The measurement function is selected by pushing the $k\Omega$ switch to the IN position. The colored area enclosing the $k\Omega$ function switch extends up and to the right enclosing the six range values for the resistance function. To select a particular resistance range, depress the range switch immediately below the desired range value. Connect the test leads; red to the V- Ω terminal and black to the COMMON terminal.

1-27. Use the following procedure to familiarize yourself

with the resistance function and to see how the range switches affect decimal point position on the LED.

1. With the test leads held apart, select the 2000 $k\Omega$ range. The LED should display an overrange indication—all digits have flashing.
2. Make a firm connection between the sampling ends of the test leads. The LED should count down to 000.0.
3. Maintain a firm contact between the ends of the test leads and sequentially select the ranges starting with the 200 Ω switch. The decimal point for each should be as follows:

Range	Display
200 Ω	00.00*
2 $k\Omega$.0000*
20 $k\Omega$	0.000
200 $k\Omega$	00.00
2000 $k\Omega$	000.0
20 $M\Omega$	0.000

* Display value will show lead resistance.

1-28. SPECIFICATIONS

1-29. Table 1-1 lists the specifications of your DMM.

Table 1-1 Specifications

ELECTRICAL:	The electrical specifications given apply for an operation temperature of 18°C to 28°C (64.4°F to 82.4°F), relative humidity up to 75%, and a 1-year calibration cycle.
FUNCTIONS:	DC volts, AC volts (AC and AC+DC), DC current, AC current, resistance, diode test.

DC VOLTS:

RANGE	RESOLUTION	ACCURACY for 1 year
±200mV	10µV	±(0.03% of reading + 4 digits)
±2V	100µV	
±20V	1mV	
±200V	10mV	
±1000V	100mV	

INPUT IMPEDANCE: 10MΩ in parallel with <100pF, all ranges.

NORMAL MODE REJECTION RATIO:>60dB at 60Hz or 50Hz.

COMMON MODE REJECTION RATIO: >90dB at dc, 50Hz or 60Hz (1kΩ unbalance) (>120dB available on request).

COMMON MODE VOLTAGE (MAXIMUM): 500V dc or peak ac.

RESPONSE TIME TO RATED ACCURACY: 1 second maximum.

MAXIMUM INPUT: 1200V dc or peak ac continuous(less than 3 second duration on both the 200mV and 2V ranges).

AC VOLTS (TRUE RMS RESPONDING, AC OR AC+DC):

VOLTAGE READOUT ACCURACY: ±(% of reading + number of digits), between 5% of range and full range.

The AC specification is based on the 50% of duty cycle.

INPUT VOLTAGE	RESOLUTION	RANGE 20Hz**	45Hz	1kHz	2kHz	10kHz	20kHz	50kHz
10mV-200mV	10µV	200mV						
0.1V-2V	100µV	2V						
1V-20V	1mV	20V	1%+15	0.5% + 15		1%+15	2%+30	5%+30
10V-200V	10mV	200V						
100V-1000V	100mV	1000V						
Not Specified								

**Typically 3 to 5 digits of rattle will be observed at full scale at 20Hz.

DC CURRENT

RANGE	RESOLUTION	ACCURACY for 1 year	BURDEN VOLTAGE
200µA	0.01µA	±(0.2% of reading +2 digits)	0.3V max
2mA	0.1µA		
20mA	1µA		
200mA	10µA		
2000mA	100µA	±(0.3% of reading +2 digits)	0.9V max
20A	1mA		

OVERLOAD PROTECTION: 200µA, 2mA, 20mA, 200mA, 2000mA 5 ranges fuse protection, 20A range, no fuse, 15 seconds max.

AC CURRENT (TRUE RMS RESPONDING, AC or AC+DC):

The AC specification is based on the 50% of duty cycle.

INPUT CURRENT	RESOLUTION	RANGE 20Hz**	45Hz	2kHz	10kHz	20kHz	BURDEN VOLTAGE
10µA-200µA	0.01µA	200µA	1%+15	0.5%+15	1%+15	2%+15	0.3V rms max
100µA-2mA	0.1µA	2mA					
1mA-20mA	1µA	20mA			Not Specified	0.9V rms max	
10mA-200mA	10µA	200mA					
100mA-2000mA	100µA	2000mA					
2000mA-20A	1mA	20A					

**Typically 3 to 5 digits of rattle will be observed at full scale at 20Hz.

CREST FACTOR RANGE: Waveforms with a Peak/RMS ratio of 1:1 to 3:1 at full scale.

RESISTANCE:

RANGE	RESOLUTION	ACCURACY for 1-Year	FULL SCALE VOLTAGE ACROSS UNKNOWN RESISTANCE
200Ω	0.01Ω	± (0.1% reading + 4 digits)	0.2V
2kΩ	0.1Ω	± (0.1% reading + 2 digits)	2V
20kΩ	1Ω		2V
200kΩ	10Ω		0.2V
2000kΩ	100Ω		2V
20MΩ	1kΩ	± (0.25% reading + 2 digits)	2V

OVERLOAD PROTECTION: 250V dc/ac rms on all ranges.

RESPONSE TIME (TO RATED ACCURACY): 5 seconds maximum on 20MΩ range
2 seconds maximum on all other ranges.

DIODE TEST: These three ranges have enough voltage to turn on silicon junctions to check for proper forward-to-back resistance. The 2kΩ range is preferred and is marked with a large diode symbol on the front panel of the instrument.

Table 1-1 Specifications (cont)

ENVIRONMENTAL

TEMPERATURE COEFECIENT: <0.1 times the applicable accuracy specification per °C for 0°C to 18°C and 28°C to 50°C (32°F to 64.4°F and 82.4°F to 122°F).

OPERATING TEMPERATURE: 0°C to 50°C (32°F to 122°F).

STORAGE TEMPERATURE: -10°C to +70°C (14°F to +158°F).

RELATIVE HUMIDITY: Up to 90%, 0°C to 35°C (32-95°F), up to 70%, 35°C to 50°C (95-122°F), except on 2000kΩ and 20MΩ, ranges where it is up to 80%, 0°C to 35°C (32-95°F).

GENERAL:

MAXIMUM COMMON MODE VOLTAGE: 500V dc, or peak ac (low terminal potential with respect to power line ground).

SIZE: 237(W) x 85(H) x 284(D) mm, see Figure 1-1.

WEIGHT: 1.4 kg.

POWER REQUIREMENTS:

LINE VOLTAGE: 100/120/220/230V $\pm 10\%$, 50/60Hz.

OPERATION ENVIRONMENT: Indoor use

Altitude up to 2000m

CAT I 1200V, CAT II 600V

Pollution Degree 2

POWER CONSUMPTION: 12VA, 8 Watts

Measurement category I is for measurements performed on circuits not directly connected to MAINS.

Measurement category II is for measurements performed on circuits directly connected to the low voltage installation.

Measurement category III is for measurements performed in the building installation.

Measurement category IV is for measurements performed at the source of the low-voltage installation.



WARNING : To avoid electrical shock, the power cord protective grounding conductor must be connected to ground.



CAUTION : To avoid damaging the instrument, do not use it in a place where ambient temperature exceeds +50°C.

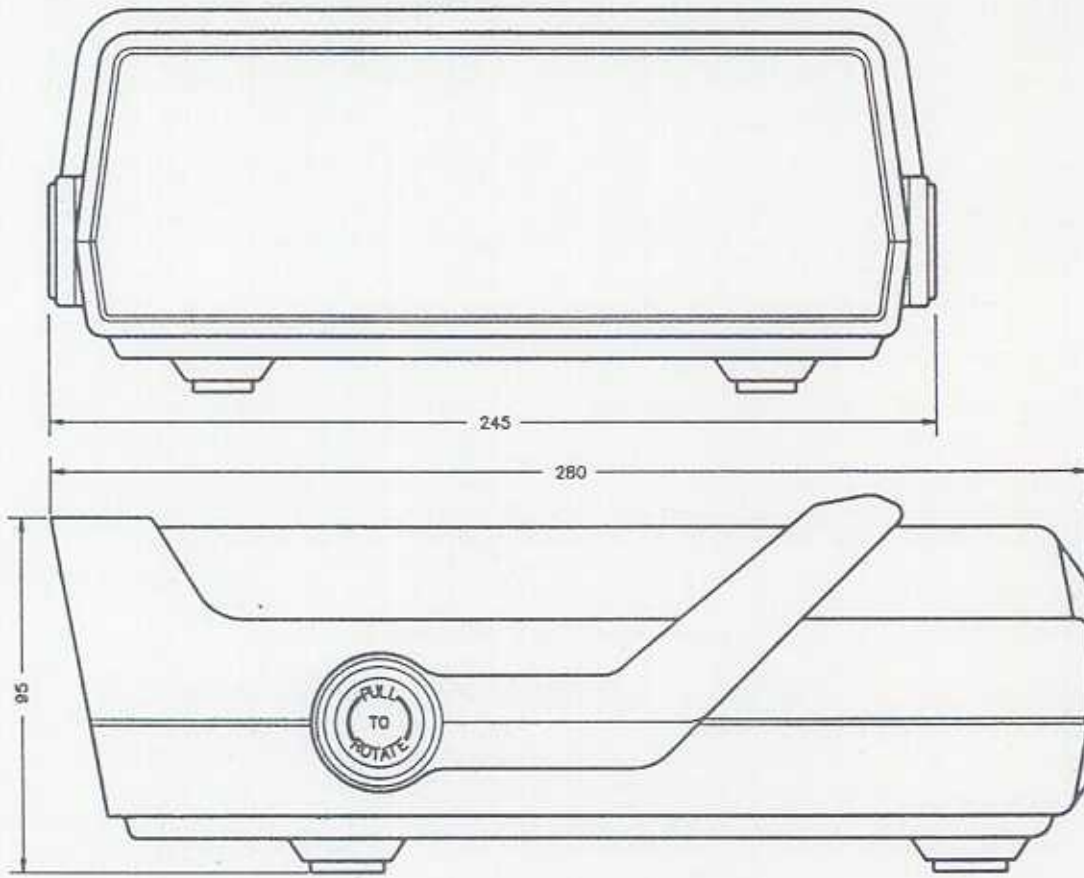

Figure 1-1. Dimensions.

Section 2

OPERATING INSTRUCTIONS

2-1. INTRODUCTION

2-2. To use your multimeter fully, there are some additional factors to be considered, such as measurement techniques, the maximum signal input levels that will not damage your instrument, and common applications. Section 2 presents this information.

2-3. OPERATING NOTES

2-4. The operating notes present the capabilities and limitations of this instrument and routine operator maintenance instructions. Everyone using an DMM should be familiar with the operating notes.

2-5. Input Overload Protection

CAUTION

Exceeding the maximum input overload limits can damage your instrument. The transient overload protection circuit is intended to protect against short duration high energy pulses. The components used limit the protection to approximately five pulses per second for 6kV 10 microsecond pulses, and about 0.6 watts average for lower amplitude pulses.

2-6. Each measurement function is equipped with input overload protection. Table 2-1 lists the overload limits for

each function.

2-7. Input Connections to Common

WARNING

TO AVOID ELECTRICAL SHOCK AND/OR INSTRUMENT DAMAGE, DO NOT CONNECT THE COMMON INPUT TERMINAL TO ANY SOURCE OF MORE THAN 500 VOLTS DC OR PEAK AC ABOVE EARTH GROUND.

2-8. This instrument may be operated with the common input terminal at a potential of up to 500V dc or ac peak with respect to earth ground. If this limit is exceeded, instrument damage or an operator safety hazard may occur.

2-9. Operating Power

2-10. This instrument is available in standard versions that use 100V, 120V, 220V or 230 V ac at 47 to 440Hz.

Table 2-1. Maximum Input Signal Limits

FUNCTION SELECTED	RANGE SELECTED	INPUT TERMINALS	MAXIMUM INPUT OVERLOAD	
V	DC	ALL RANGES	1200V dc or peak ac	
	AC	20V, 200V, 1000V	V/Ω and COMMON	1000V rms continuous
		2V, 200mV		1000V rms for no longer than 15 seconds
2A or 20A	DC or AC	2A/20A and COMMON	Fuse protected: 2A, 250V fuse (20A range no fuse).	
kΩ	ALL RANGES	V-Ω and COMMON	250V dc or ac rms	

2-11. MEASUREMENT TECHNIQUES

2-12. The information in this portion of Section 2 offers you techniques in measurement and interpretation of measurements that may extend the usefulness of your DMM. These techniques – common throughout the electronics industry – have been tailored specifically for this instrument. Except for some common ac considerations, the techniques have been separated by instrument function. The ac considerations are presented last.

2-13. Voltage Measurement Techniques

2-14. In Section 1 we discussed the operation of the controls and terminals used to make voltage measurements (V). To use your DMM effectively, there are other factors of which you should be aware.

2-15. CONVERTING VOLTAGE MEASUREMENTS

2-16. Your instrument is one of the new family of DMM that actually measure the true rms value of an ac or ac+dc signal. This is a feature that allows accurate measurement of common waveforms like distorted or mixed frequency sine waves, square waves, sawtooths, noise, pulse trains (with a duty cycle of at least 10%), etc. In the past, the methods of ac measurement used have introduced large errors in the readings. Unfortunately, we've all grown used to these erroneous voltage readings and depend upon them to indicate whether or not a piece of equipment is working correctly. The data contained in Figure 2-1 should help you to convert between measurement methods.

2-17. CIRCUIT LOADING ERROR

2-18. Connecting most voltmeters to a circuit may change the operating voltage of the circuit if it loads the circuit down. As long as the circuit resistance (source impedance) is small compared to the input impedance of the meter, the error is not significant. For example, when measuring voltage with your meter, as long as the source impedance is 1 k Ω or less, the error will be $\leq .01\%$. If circuit loading does present a problem, the percentage of error can be calculated using the appropriate formula in Figure 2-2.

2-19. COMBINED AC AND DC SIGNAL MEASUREMENTS

2-20. The waveform shown in Figure 2-3 is a simple example of an ac signal riding on a dc level. To measure waveforms such as these, first measure the rms value of the ac component using the ac function of your meter. Measure the dc component using the dc function of your instrument. The relationship between the total rms value of the waveform and the ac component and the dc component is:

$$\text{RMS Total} = \sqrt{(\text{ac component rms})^2 + (\text{dc component})^2}$$

2-21. INSIGNIFICANCE OF INHERENT METER OFFSET

2-22. If you short the input of your meter while the ac voltage function is selected, you may have a reading of less than 10 digits on the display. This small offset is caused by the action of amplifier noise and offset of the true

rms converter. This offset will not significantly affect any readings until you try to measure signals almost at the floor of the meter. For example:

GIVEN: An offset of 40 digits (.40mV, 200mV range).

Input signal = 10mV, 200mV range

$$\begin{aligned}\text{Total rms} &= \sqrt{10^2 + 0.4^2} \\ &= \sqrt{100 + 0.16} \\ &= \sqrt{100.16} \\ &= 10.01\text{mV}\end{aligned}$$

or using a realistic offset for your instrument,

GIVEN: A typical offset of 20 digits (.20mV, 200mV range).

Input signal = 10mV, 200mV range

$$\begin{aligned}\text{Total rms} &= \sqrt{10^2 + 0.2^2} \\ &= \sqrt{100 + 0.04} \\ &= \sqrt{100.04} \\ &= 10.00\end{aligned}$$

the meter will read this as 10.00mV.

2-23. Current Measurement Techniques

WARNING

INSTRUMENT DAMAGE AND OPERATOR INJURY MAY RESULT IF THE FUSE BLOWS WHILE CURRENT IS BEING MEASURED IN A CIRCUIT WHICH EXHIBITS AN OPEN CIRCUIT VOLTAGE GREATER THAN 600 VOLTS.

2-24. BURDEN VOLTAGE ERROR

2-25. When a meter is placed in series with a circuit to measure current, you may have to consider an error caused by the voltage drop across the meter (in this case, across the protective fuses and current shunts). This voltage drop is called burden voltage. The maximum fullscale burden voltages for your instrument are: 0.3V for the four lowest ranges, and 0.9V for the 2000mA, 20A ranges. These voltage drops can affect the accuracy of a current measurement if the current source is unregulated and the resistance of the shunt and fuse represents a significant part (1/1000 or more) of the source resistance. If burden voltage does present a problem, the percentage error can be calculated using the formula in Figure 2-4. This error can be minimized by selecting the highest current range that provides the necessary resolution.







2-26. Resistance Measurement Techniques

2-27. AUTOMATIC TEST LEAD COMPENSATION

2-28. When measuring low resistances, test lead resistance interferes with low resistance readings and usually has to be subtracted from resistance measurements for accuracy.

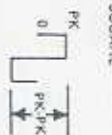
2-29. DIODE TEST

Figure 2-1. Voltage Conversion

AC-COUPLED INPUT WAVEFORM	PEAK VOLTAGES		METERED VOLTAGE				DC AND AC TOTAL RMS **TRUE RMS= $\sqrt{ac^2 + dc^2}$
	PK-PK	0-PK	AC COMPONENT ONLY *RMS CAL	AC TRUE RMS	DC COMPONENT ONLY		
SINE 	2.828	1.414	1.000	1.000	0.000	1.000	
RECTIFIED SINE (FULL WAVE) 	1.414	1.414	0.421	0.435	0.900	1.000	
RECTIFIED SINE (HALF WAVE) 	2.000	2.000	0.704	0.771	0.636	1.000	
SQUARE 	2.000	1.000	1.110	1.000	0.000	1.000	
RECTIFIED SQUARE 	1.414	1.414	0.705	0.707	0.707	1.000	
RECTANGULAR PULSE  $D = X/Y$ $K = \sqrt{D \cdot D^2}$	2.000	2.000	2.22K	2K	2D	$2\sqrt{D}$	
TRIANGLE SAWTOOTH 	3.464	1.732	0.960	1.000	0.000	1.000	

* RMS CAL IS THE DISPLAYED VALUE FOR AVERAGE RESPONDING METERS THAT ARE CALIBRATED TO DISPLAY RMS FOR SINE WAVES.
** Your Digital Multimeter.

Figure 2-2. Circuit Loading Error Calculations

1. DC VOLTAGE MEASUREMENTS

Loading Error in % = $100 \times R_s \div (R_s + 10^7)$
 Where: R_s = Source resistance in ohms of circuit being measured.

2. AC VOLTAGE MEASUREMENTS

First, determine input impedance, as follows:

$$Z_{in} = \frac{10^7}{\sqrt{1 + (2\pi F \cdot R_{in} \cdot C)^2}}$$

Where: Z_{in} = effective input impedance
 $R_{in} = 10^7$ ohms
 $C_{in} = 100 \times 10^{-12}$ Farads
 F = frequency in Hz

Then, determine source loading error as follows:*

$$\text{Loading Error in \%} = 100 \times \frac{Z_s}{Z_s + Z_{in}}$$

Where: Z_s = source impedance
 Z_{in} = input impedance (calculated)

*Vector algebra required

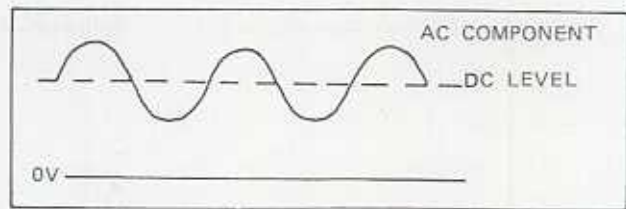
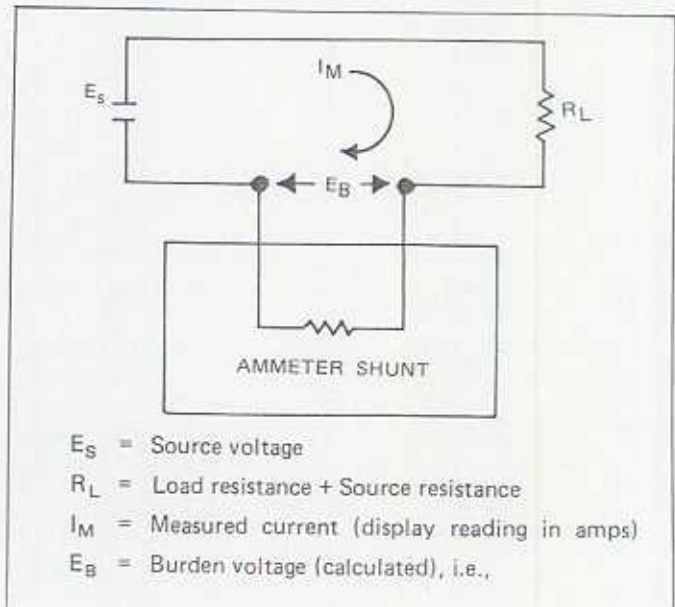

Figure 2-3. RMS Values.

Figure 2-4. Calculating Burden Voltage Error



Display reading expressed as a % of full scale ($100 \times \frac{\text{READING}}{\text{FULL SCALE}}$) times full scale burden voltage for selected range. See table.

RANGE	F.S. BURDEN VOLTAGE
200 μ A to 200mA	0.3V max.
2000mA, 20A	0.9V max.

Maximum current error due to Burden Voltage

$$\text{IN \%} = 100 \times \frac{E_B}{E_S - E_B}$$

$$\text{IN MILLIAMPS} = \frac{E_B \times I_M}{E_S - E_B}$$

Examples: $E_S = 14\text{V}$, $R_L = 9\Omega$, $I_M = 1497.0\text{ mA}$,

$$E_B = 100 \times \frac{1497.0}{2000.0} \times 0.9 \text{ (from Table)} = 74.9\% \text{ of } 0.9 = 0.674\text{V}$$

$$\text{Maximum error in \%} = 100 \frac{.674}{14 - .674} = 100 \frac{.674}{13.326} = 5.06\%$$

Increase displayed current by 5.06% to obtain true current.

$$\frac{\text{Maximum error in milliamps}}{\text{in milliamps}} = \frac{.674 \times 1497.0}{14 - .674} = \frac{1009.0}{13.326} = 75.7\text{mA}$$

Increase displayed current by 75.7mA to obtain true current.

2-30. The five resistance ranges with a diode symbol beside the range value have a high enough measurement voltage to turn on a silicon junction. This range (2k Ω) can be used to check silicon diodes and transistors. The 2k Ω range is preferred. It is marked with the largest diode symbol.

2-31. AC Measurement Techniques

2-32. When making precise measurements of ac signals, there are special parameters that must be considered such as the type of ac converter the meter uses (average, rms, etc.), crest factor, bandwidth, noise, etc.

2-33. TRUE RMS

2-34. In order to compare dissimilar waveforms, calculate Ohm's law statements or power relationships, you must know the effective value of a signal. If it is a dc signal, the effective value equals the dc level. If the signal is ac, however, we have to use the root mean square or rms value. The rms value of an ac current or ac voltage is defined as being numerically equal to the dc current or voltage that produces the same heating effect in a given resistance that the ac current or voltage produces.

2-35. In the past, average responding converters were the type of converter most widely used. Theoretically, the rms value of a pure sine wave is $1/\sqrt{2}$ of the peak value and the average value is $2/\pi$ of the peak value. Since the meters converted to the average value, the rms value was $1/\sqrt{2} \div 2/\pi = \pi/(2\sqrt{2}) = 1.11$ of the average value when measuring a sine wave. Most meters used an average

responding converter and multiplied by 1.11 to present true rms measurements of sine waves. As the signal being measured deviated from a pure sine wave, the errors in measurement rose sharply. Signals such as square waves, mixed frequencies, white noise, modulated signals, etc., could not be accurately measured. Rough correction factors could be calculated for ideal waveforms if the signal being measured was distortion free. Noise-free, and a standard waveform. The true rms converter in your meter provides direct, accurate measurement of these and other signals. Since this DMM is ac and dc coupled, refer to the section on Voltage Measurement Techniques for combined ac and dc signal measurements.

2-36. CREST FACTOR

2-37. Crest factor range is one of the parameters used to describe the dynamic range of a voltmeter's amplifiers. The crest factor of a waveform is the ratio of the peak to the rms voltage. In waveforms where the positive and negative half cycles have different peak voltages, the higher voltage is used in computing crest factor. Crest factors start at 1.0 for a square wave (peak voltage equals rms voltage).

2-38. Your instrument has a crest factor range of 1.0 to 3.0 at full-scale. Going down from full-scale, the crest factor capability increases from 3.0 to:

$$\frac{\text{Full-Scale} \times 3}{\text{RMS Value}} \text{ (i.e., 6 at half-scale)}$$

If an input signal has a crest factor of 3.0 or less, voltage measurements will not be in error due to dynamic range limitations at full-scale. If the crest factor of a waveform is not known, and you wish to know if it falls within the crest factor of your meter, measure the signal with both your meter and an ac coupled oscilloscope. If the rms reading on your meter is 1/3 of the peak voltage on the waveform or less, then the crest is 3.0. For readings at less than full-scale, use the preceding formula to determine the maximum crest factor. At half-scale the maximum crest factor is:

$$\frac{2 \times 3}{1} = 6$$

2-39. The waveforms in Figure 2-5 show signals with increasing values of crest factor. As you can see from the series of waveforms, a signal with a crest factor above 3.0 is unusual.

2-40. For an ac coupled pulse train:

$$\text{Crest Factor} = \sqrt{1/D - 1}$$

Where D = duty cycle or the ratio of pulse width to cycle length. Reversing this formula, we find that your meter can accurately measure pulse trains at full-scale with a duty cycle above 10% without being limited by crest factor.

$$\begin{aligned} \text{Crest Factor} = 3.0 &= \sqrt{1/D - 1} \\ 9.0 &= 1/D - 1 \\ 10.0 &= 1/D \\ D &= 1/10 = 10\% \end{aligned}$$

2-41. BANDWIDTH

2-42. Bandwidth defines the range of frequencies where the response by the voltmeter's amplifiers is no more than 3 dB down (half-power levels). Your instrument has a bandwidth of greater than 200kHz.

2-43. SLEW RATE

2-44. Slew rate is also called the rate limit or the voltage velocity limit. It defines the maximum rate of change of the output of the amplifiers for a large input signal. Slew rate limitations are not a factor in measuring voltages within specified frequencies and amplitude limits of this DMM.

2-45. RISE AND FALL TIME EFFECT ON ACCURACY

2-46. The rise and fall time of a waveform are the length of time it takes a waveform to change between the points that are 10% and 90% of the peak value. When discussing these periods, we'll only mention rise time. Errors due to rise or fall time can be caused either by bandwidth or slew rate limitations. Slew rate should not affect your measurement with this DMM.

2-47. An approximate way of converting bandwidth to rise time limit is to divide 0.35 by the 3 dB down frequency. For your instrument this will be $0.35/200\text{kHz} = 1.75 \mu\text{sec}$. The following example will help you to calculate errors due to this limitation when measuring rectangular pulses. These calculations will be rough because ideal waveforms are used in analysis.

Figure 2-5. Crest Factor







WAVEFORM	CREST FACTOR
SQUARE WAVE 	1.0
SINE WAVE 	1.414
TRIANGLE SAWTOOTH 	1.732
MIXED FREQUENCIES 	1.414 to 2.0
SCR OUTPUT OF 100% - 10% 	1.414 to 3.0
WHITE NOISE 	3.0 to 4.0
AC COUPLED PULSE TRAIN 	3.0
SPIKE 	> 9.0

Figure 2-6. Components of a Rectangular Waveform

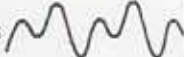

2-48. Ideally, the rectangular pulses would have zero rise and fall time and would be the right angled waveform shown in Figure 2-6, Part A. In practice, every waveform has a rise and fall time and looks more like the waveform in Figure 2-6, Part B. When calculating the error caused by the bandwidth of your instrument, we will assume that the rise and fall time equals the slew rate of 1.75 μsec . To do this we will calculate the values for the theoretical signal with zero rise and fall time, then calculate the values for a signal with the same period but with

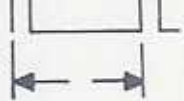
Figure 2-7. Rise Time/Fall Time Example

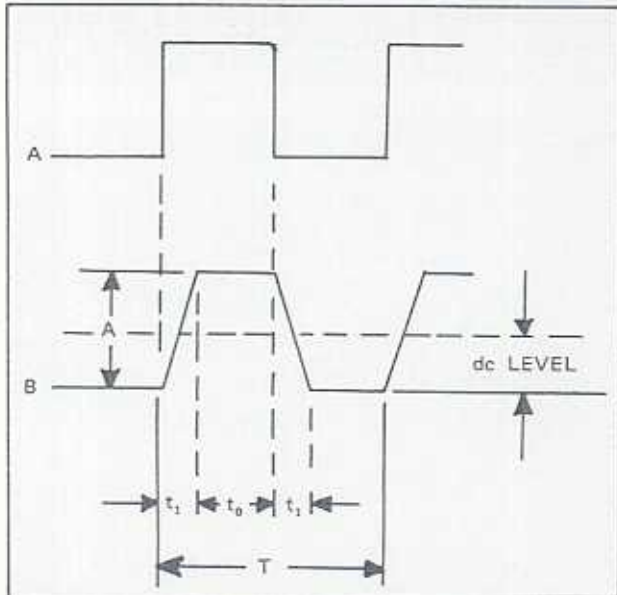
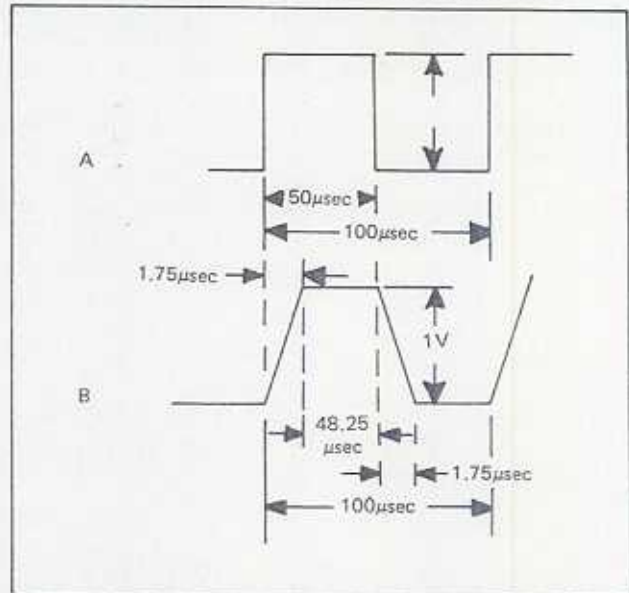

total slope periods equal to 1.75 μsec . A comparison of the results will show the measurement error due to the finite bandwidth. Using Figure 2-6, Part B, for a reference, the total rms and dc levels are:

$$E_{\text{total rms}} = A \sqrt{\frac{3t_0 + 2t_1}{3T}}$$

$$E_{\text{dc}} = A \frac{(t_0 + t_1)}{T}$$

2-49. Since we can calculate two values, to find what your meter measures, use the formula:

$$E_{ac\ rms} = \sqrt{(E_{total\ rms})^2 - (E_{dc})^2}$$

2-50. Let's look at the waveform in Figure 2-6, Part B. When using your meter to measure the ac component of the signal, the display will indicate the rms value of the ac signal riding on the dc level. (This dc level is the average value of the waveform relation to the baseline.) The total rms value of the waveform can be calculated using the relationship:

$$E_{total\ rms} = \sqrt{E_{ac\ rms}^2 + E_{dc}^2}$$

2-51. For our example let's use a 10kHz pulse train of 50 μ sec pulses with a peak value of 1V. Ideally, the pulses would have a zero rise time as shown in Figure 2-7, Part A.

$$E_{total\ rms} = 1 \sqrt{\frac{3(50) + 2(0)}{3(100)}} = \sqrt{\frac{150+0}{300}} = \sqrt{\frac{1}{2}}$$

$$E_{total\ rms} = 0.707$$

$$E_{dc} = 1 \left(\frac{50+0}{100} \right) = \frac{50}{100} = 0.5$$

$$\text{So, the } E_{ac\ rms} = \sqrt{(0.707)^2 - (0.5)^2} = \sqrt{0.50-0.25}$$

$$E_{ac\ rms} = \sqrt{0.25} = 0.5$$

2-52. When the maximum distortion in rise time of 1.75 μ sec is assumed, the signal becomes the isosceles trapezoid

waveform shown in Figure 2-7, Part B. In this case,

$$E_{total\ rms} = \sqrt{\frac{3(48.25) + 2(1.75)}{3(100)}} = \sqrt{\frac{144.75 + 3.50}{300}}$$

$$E_{total\ rms} = \sqrt{\frac{148.25}{300}} = \sqrt{0.494} = 0.703$$

$$E_{dc} = 1 \frac{48.25 + 1.75}{100} = \frac{50}{100} = 0.50$$

$$\text{So, } E_{ac\ rms} = \sqrt{(0.703)^2 - (0.50)^2} = \sqrt{0.494 - 0.25}$$

$$E_{ac\ rms} = (\sqrt{0.244} = 0.494)$$

Note that the E_{dc} stayed the same.

So, the errors are: In $E_{total\ rms}$: -0.6%
In $E_{ac\ rms}$: -1.2%

2-53. OPERATION

2-54. Use the following procedure to operate your DMM:

1. Connect your DMM to operating power and set the POWER switch to the ON position.
2. Select the desired instrument function and range.
3. Connect the test leads to the circuit to be measured. Be sure that you do not connect your DMM to a source that exceeds the maximum safe operating limits presented in the operating notes in this section.

2-55. APPLICATIONS

2-56. The test applications described in the following paragraphs are suggested as useful extensions of your meter's capabilities. They are not meant to be the equivalent of manufacturer's recommended test methods. They are intended to provide you with repeatable, meaningful indications which allow you to decide whether the device being tested is good, marginal, or defective.

Section 3

MAINTENANCE

WARNING

THESE SERVICING INSTRUCTIONS ARE FOR USE BY QUALIFIED PERSONNEL ONLY. TO AVOID ELECTRICAL SHOCK, DO NOT PERFORM ANY SERVICING OTHER THAN THAT CONTAINED IN THE OPERATING INSTRUCTIONS UNLESS YOU ARE QUALIFIED TO DO SO.

3-1. INTRODUCTION

3-2. This section contains the maintenance information for this Digital Multimeter. This information is divided into service information, general maintenance, a group of performance tests, a calibration adjustment procedure, and troubleshooting. The performance tests are recommended as an acceptance check when the instrument is first received and should be completed as necessary to verify that your DMM is operating within the specification

limits listed in Section 1. A calibration cycle of 1-year is recommended to maintain the specifications given in Section 1 of this manual. The test equipment required for both the performance test and the calibration adjustment procedure is listed in Table 3-1. If the recommended test equipment is not available, instruments having equivalent specifications may be used.

3-3. SERVICE INFORMATION

3-4. This DMM is warranted for a period of 1-year upon delivery to the original purchaser. Conditions of the warranty are given on the last page of this manual.

3-5. Malfunctions that occur within the limits of the warranty will be corrected at no charge. Simply mail the instrument postpaid to your nearest authorized Service Center. Dated proof-of-purchase will be required for all in-warranty repairs.

3-6. Factory authorized service centers are also available for calibration and/or repair of instruments that are beyond their warranty period.

3-7. GENERAL INFORMATION

3-8. Access Information

NOTE

To avoid contaminating the pcb with oil from the fingers, handle the pcb by its edges or wear gloves. If the pcb does become contaminated, refer to the cleaning procedure given later in this section.

Table 3-1. Recommended Calibration

INSTRUMENT TYPE	REQUIRED CHARACTERISTICS	RECOMMENDED MODEL
Calibrator	DC Voltage 0 to 1000V ± .006% AC Voltage 100Hz 0 to 750V ± .06% 200Hz 0 to 2V ± .06% 1kHz 0 to 750V ± .06% 10kHz 0 to 100V ± .06% 20kHz 0 to 100V ± .1% 50kHz 0 to 20V ± .6% DC Current 0 to 2000mA ± 0.35% AC Current 19mA, 100Hz ± .1% Resistance 100Ω, 1kΩ ± .01% 10kΩ, 100kΩ ± .005% 1MΩ, 10MΩ ± .05%	John Fluke Model 5100B
Calibration Leads	24" Shielded cable with a double balance plug at both ends.	Pomona 28C-24

3-9. CALIBRATION ACCESS

3-10. Use the following procedure to gain access to the calibration adjustments of this DMM.

1. Set the POWER switch to the OFF position and remove the power cord plug from the receptacle in the rear of the instrument.
2. Remove the phillips screw from the Bottom of your DMM.
3. Grasp the front panel and slide the instrument out of the case.
4. Turn the instrument upside-down as viewed from the front panel.
5. All adjustments necessary to complete the cali-

bration procedure are now accessible.

6. For reassembly, reverse the procedure (be careful to align the grooves in the sides of the front panel with the guides located inside the case and to bend the flexible interconnect inwards and out of the way).

3-11. MAIN PCB ACCESS

3-12. Use the following procedure to gain access to all the components and test points on the Main PCB assembly for troubleshooting and repairing.

1. Complete the calibration access procedure.
2. Remove the front panel using the following procedure:
 - a. The V-Ω input line and the COMMON input line are attached to the front panel by a snap connector. Unplug these lines.
 - b. Slide the fuse spring forward to the edge of the slide panel.
 - c. Pull the wire up through the slot in the fuse holder barrel.
 - d. Pull the spring and the fuse contact up through the hole in the fuse holder barrel.
 - e. Reinstall the fuse and fuse holder.
 - f. Turn the instrument component-side-down.
 - g. Carefully pull the front panel free of the switches.
3. To install the Main PCB, reverse this procedure, being careful to install the pcbs and the shields in their respective guides.

3-13. DISPLAY ACCESS

3-14. Use the following procedure to remove or replace the LED:

1. Carefully lay the display P.C.B. to one side.
2. Both the Main and Display PCBs should now be flat on your workbench, component-side-up.
3. Tilt the Display PCB towards the Main PCB, and remove the shield plate connecting the display PCB.
4. For reassembly, reverse the mentioned procedure.

3-15. Changing Input Power Configuration.

3-16. The standard instrument has one of three transformers: 100V, 120V, 220V or 230V ac, 47-440Hz. The transformer must be changed to accommodate a different line voltage.

3-17. Fuse Replacement



WARNING: For continued fire protection, replace fuse only with the specific type and rating, and disconnect the power cord before replacing fuse.

3-18. This DMM has two fuses installed 0.125A or 0.08A 250V for line protection, 2A 250V for 2A current measurement.

3-19 Cleaning



CAUTION: Do not use atomistic hydrocarbons or chlorinated solvents for cleaning. These solutions will react with the plastic materials used in the instruments.

3-20. Clean the front panel and case with a mild solution of detergent and water. Clean dust from the circuit board with clean, dry, low pressure air(20 psi or less). Contaminants can be removed from the PCB using demineralized water and a soft brush (remove the display assembly before washing the main PCB and avoid getting excess amounts of water on the switches). Dry with clean, dry, low pressure air and then bake at 50 to 60°C (122 to 140°F) for 24 hours.

3-12. PERFORMANCE TESTS

3-22. The performance tests are used to compare the performance of this instrument to the specifications listed in Section 1 of this manual. If the instrument fails any portion of the performance tests, calibration and/or repair is indicated. Throughout the tests, your DMM will be referred to as the UUT(Unit Under Test).



NOTE: Allow the UUT to warm-up a minimum of 30 minutes and conduct the test at an ambient temperature of $23 \pm 5^{\circ}\text{C}$ ($73 \pm 9^{\circ}\text{F}$)

3-23. DISPLAY TEST

3-24. Complete the following procedure to verify proper operation of the display annunciators and each segment of each digit in the display:

1. Select $k\Omega$, 200 Ω range with an open circuit input.
2. Verify that the overrange indication, the LED will be flashed at the all digit location.

3. Short the input, select each range listed in Table 3-2 and verify that the decimal point is positioned as indicated.
4. Select DC V, 200V range.
5. Connect the DMM Calibrator to the UUT: HI to the V-Ω terminal and LO to the COMMON terminal.
6. Apply +188.88V dc and adjust the calibrator until the UUT displays +188.88 exactly.

Table 3-2 Display Test

SELECT RANGE	DISPLAY
200Ω	00.00*
2kΩ	.0000*
20kΩ	0.000
200kΩ	00.00
2000kΩ	000.0
20MΩ	0.000

*The least significant digits may change by several digits from zero, depending on your test lead resistance.

3-25. Linear Voltage Test

3-26. Use the following procedure to verify the proper operation of both the AC and DC V function.

1. Select DC V, 200mV range.

2. Connect the DMM Calibrator to the UUT: HI to the V-Ω terminal and LO to the COMMON terminal.
3. For each step of Table 3-3, set the ACV/DCV switch to the indicated position, select the listed range, program the calibrator for the corresponding input to the UUT, and verify that the UUT display value lies within the indicated limits.

Table 3-3. Linear Voltage Test

Step	UUT SWITCH POSITIONS		UUT INPUT		DISPLAY READING
	Function	Range	Level	Frequency	
1	DCV	200mV	+190mV dc		+189.90~+190.10
2			-190mV dc		-189.90~-190.10
3		2V	+1.9V dc		+1.8990~+1.9010
4			-1.9V dc		-1.8990~-1.9010
5		20V	+19V dc		+18.990~+19.010
6		200V	+190V dc		+189.90~+190.10
7		1200V	+1000V dc		+999.3~+1000.7
8		2V	short		<.0020
9	ACV	200mV	190mV ac rms	100Hz	188.90~191.10
10				10kHz	187.95~192.05
11				50kHz	180.20~199.80
12		2V	100 mV ac rms	100Hz	980~1020
13				100Hz	1.8890~1.9110
14				10kHz	1.8795~1.9205
15		20V	19V ac rms	50kHz	1.8020~1.9980
16				100Hz	18.890~19.110
17				10kHz	18.795~19.205
18		200V	190V ac rms	50kHz	18.020~19.980
19				100Hz	188.90~191.10
20				10kHz	98.85~101.15
21	1000V	1000V ac rms	100Hz	993.5~1006.5	
22			1kHz	993.5~1006.5	

3-27. Current Test

3-28. Use the following procedure to verify proper operation of both the AC and DC mA measurement functions:

1. Select DC mA, 200 μ A range.
2. Connect the DMM Calibrator to the UUT: HI to the 2A terminal and LO to the COMMON terminal.
3. For each step in Table 3-4, select the listed range, program the calibrator for the corresponding UUT input, and verify that the UUT display value lies within the indicated limits.
4. Set the FUNCTION switch to the AC mA position and select the 20 mA range.
5. Program the calibrator for a UUT input of 19,000 mA rms at a frequency of 100 Hz.
6. Verify that the UUT display value lies between 18.890 and 19.110.

3-29. Resistance Test

3-30. Use the following procedure to verify the accuracy of the $k\Omega$ measurement function:

1. Select $k\Omega$, 200 Ω range.
2. Connect the UUT to the calibrator: V- Ω terminal to HI and COMMON terminal to LO.
3. For each step in Table 3-5, select the listed range, program the calibrator for the corresponding input, to the UUT and verify that the UUT display is within the indicated limits.

Table 3-4. Direct Current Test

STEP	SELECT RANGE	INPUT	DISPLAY READING
1	200 μ A	190 μ A	189.61 to 190.39
2	2 mA	1.9 mA	1.8961 to 1.9039
3	20 mA	19 mA	18.961 to 19.039
4	200 mA	190 mA	189.61 to 190.39
5	2000 mA	1900 mA	1894.1 to 1905.9
6	20 A	19 A	18.941 to 19.059

Table 3-5. Resistance Test

STEP	SELECT RANGE	INPUT	DISPLAY READING
1	200 Ω	Short	00.00 to 00.07
2	200 Ω	100 Ω	99.86 to 100.14
3	2k Ω	1k Ω	.9988 to 1.0012
4	20k Ω	10k Ω	9.988 to 10.012
5	200k Ω	100k Ω	99.88 to 100.12
6	2000k Ω	1000k Ω	997.3 to 1002.7
7	20M Ω	10M Ω	9.973 to 10.027

3-31. CALIBRATION ADJUSTMENTS

3-32. The calibration adjustment procedure should be used any time your instrument has been repaired or fails to pass the Performance Test. Perform the R306A, R336A may be change if U301 are replaced or if VR302, VR304

do not have enough adjustment range; perform the U501 maybe changed if VR502 do not have enough adjustment range. The RMS Converter Offset Adjustment should not normally need to be done. Adjust only if VR501 (AC) does not have enough adjustment range or if the display reads .0010 or greater with AC V, 2V range selected and the input shorted.

NOTE

Allow the UUT to warm up a minimum of 30 minutes and conduct the calibration at an ambient temperature of $23 \pm 5^{\circ}\text{C}$ ($73 \pm 9^{\circ}\text{F}$).

3-33. DC Calibration

3-34. On the UUT select DC V, 2V range, and connect the UUT to the DMM Calibrator, V- Ω terminal to HI and COMMON to LO. For each step in Table 3-6, select the listed range, program the calibrator for the corresponding UUT input, and make the specified adjustment or check.

3-35. AC Calibration

3-36. Select AC V, 2V range, and follow the steps in Table 3-7.

Table 3-6. DC Calibration

Step	Range	Input	Adjust	Display Limits
1	200mV	Short	VR303	Less than ± 00.04
2	2V	$+1.9000\text{V}$	VR302	$+1.9000\text{V}$ exactly
3	200mV	$+190.00\text{mV}$	VR304	$+190.00\text{mV}$ exactly
4	200V	$+190.00\text{V}$	VR202	$+190.00\text{V}$ exactly
5	1000V	$+1000.0\text{V}$	VR203	$+1000.0\text{V}$ exactly

Table 3-7. AC Calibration

step	Range	Input	Freq.	Adjust	Display Limits
1	2V	Short		VR501	Less than .0010
2	2V	1.900	400Hz	VR502	1.8995 to 1.9005
3				SVC202 SVC203	ADJ to mechanical center
4	200mV	190.0mV	50kHz	SVC316	185.70 to 186.30
5(a)	200V	190.00V	4kHz	SVC201	189.90 to 190.10
(b)	20V	19.000V	4kHz	SVC202	18.990 to 19.010
6(a)	1000V	1000.0V	1kHz	SVC201	999.5 to 1000.5
(b)	20V	19.000V	4kHz	SVC203	18.990 to 19.010

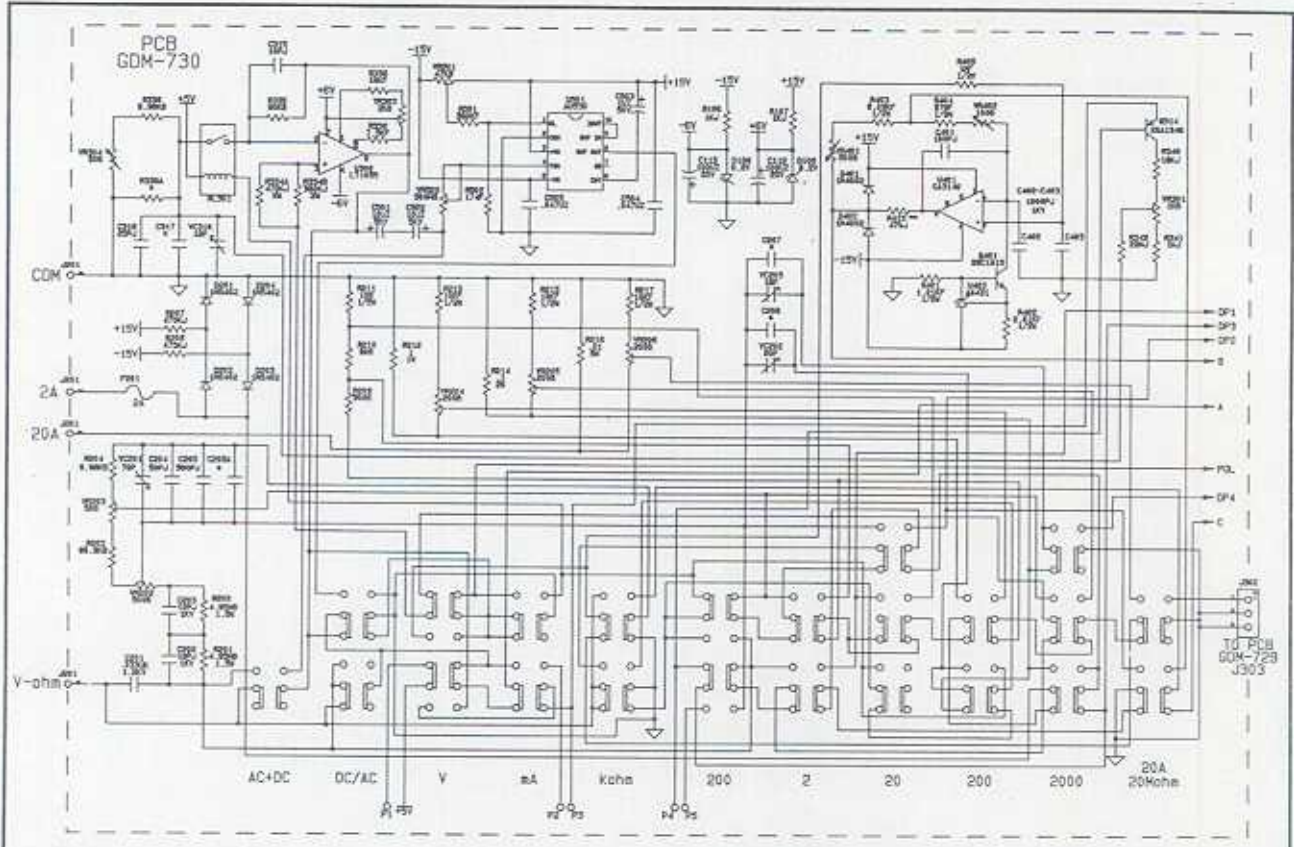

DRAWN BY	CHECKED BY	APPROVED BY	MODEL NO	
			DESCRIPTION	PAGE: 4 RANGE SELECT
			DRAWING NO	8145-3-1

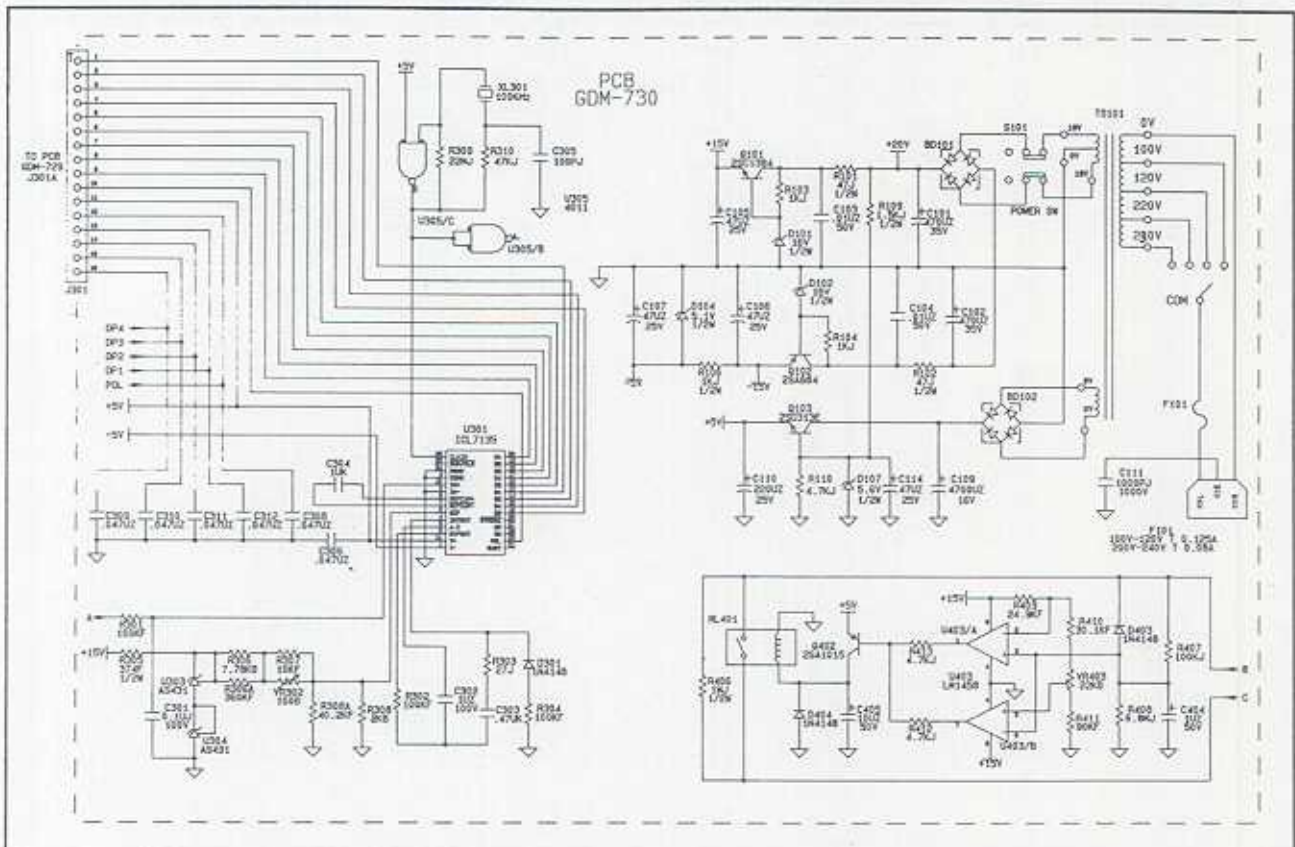

DRAWN BY	CHECKED BY	APPROVED BY	MODEL NO	
			DESCRIPTION	A/D CONVERTER & POWER
			DRAWING NO	8145-3-2

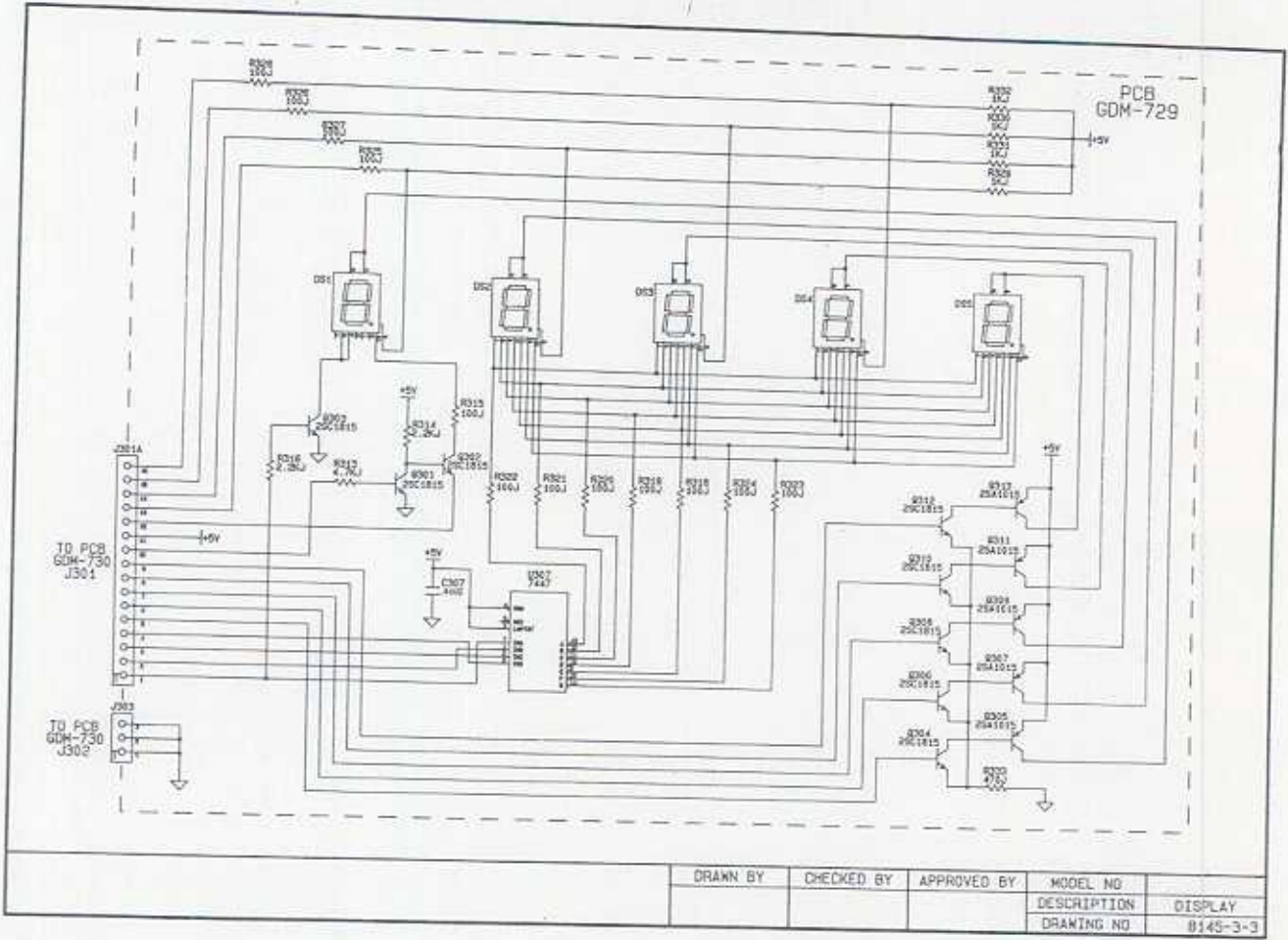

DRAWN BY	CHECKED BY	APPROVED BY	MODEL NO	
			DESCRIPTION	DISPLAY
			DRAWING NO	8145-3-3